

## SEG Graphic Installation

### STEP 1: Attach Corners

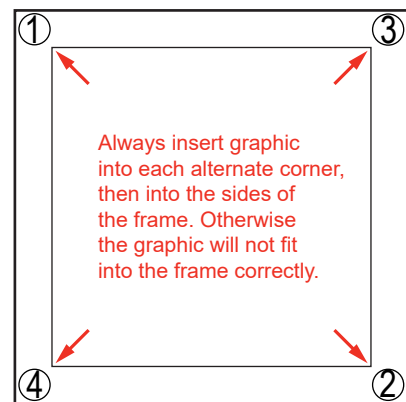

Insert narrow side of silicone welt into the channel at corner 1, with fabric to the outside.

Repeat for opposite corner 2, then corner 3, then corner 4.



### STEP 2: Attach Middle

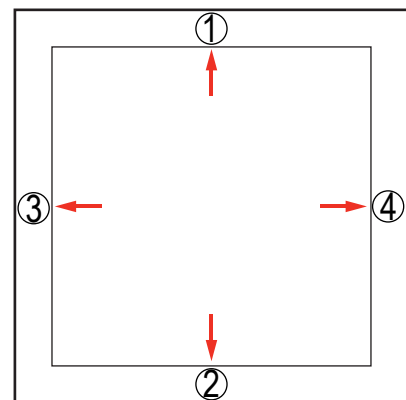

Once corners are attached, press the middle of edge 1 into the channel. Then press middle of edge 2 into the channel on opposite side.

Repeat with edge 3 & 4.

### STEP 3: Attach Sides

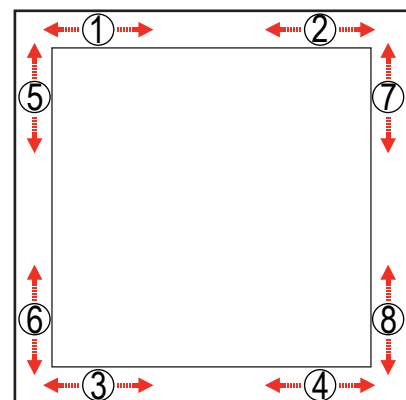

Once the middle of sides are attached, fully press the silicone welt into the channel, between center and corner at location 1. Repeat the process between center and corner at location 2.



Do the same for welt on opposite side, at locations 3 & 4. Then repeat for locations 5 & 6 and 7 & 8.



To remove the graphic from the frame, locate the fabric pull tab. Gently pull on the tab to remove the graphic.

Item	Qty.	Description
1	1	48" h TSP46 Vertical Extrusion
2	1	48" h TSP46 Vertical Extrusion
3	1	48" h TSP46 Vertical Extrusion
4	1	48" h TSP46 Vertical Extrusion
5	1	36" w TSP46 Horizontal Extrusion
6	1	36" w TSP46 Horizontal Extrusion
--	2	SF-14 Boomerang Leg

### \* Boomerang Foot Attachment

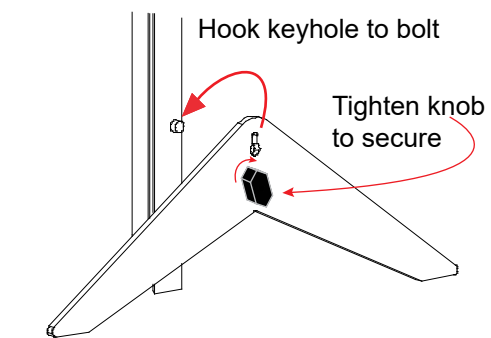

### \* Tool-less Straight Connector

1. Place extrusions end-to-end.

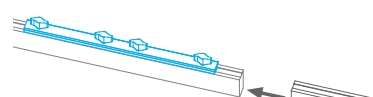

2. Slide tool-less connectors across seam of extrusions.

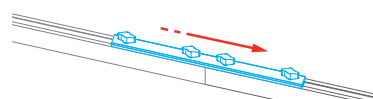

3. Tighten all knobs to secure connection.

### \* Tool-less Corner Connector

1. Slide extrusion onto Corner Connector.

2. Tighten all knobs to secure connection.

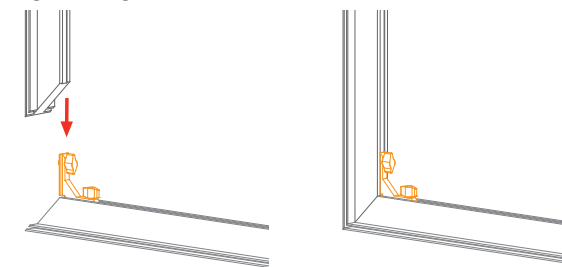

Keep corner connectors attached to horizontal extrusions.

Steps:

- 1) Assemble verticals [1-2], [3-4] together using **straight connectors**.
- 2) Connect vertical assemblies [1/2], [3/4] between horizontals [5,6] using **corner connectors**.
- 3) Attach **Boomerang feet** to sides of frame assembly.
- 4) Apply SEG graphic to front of assembled frame.

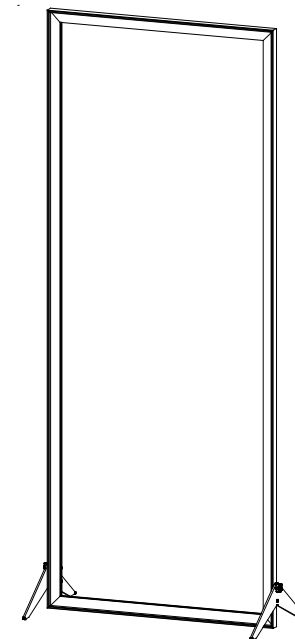
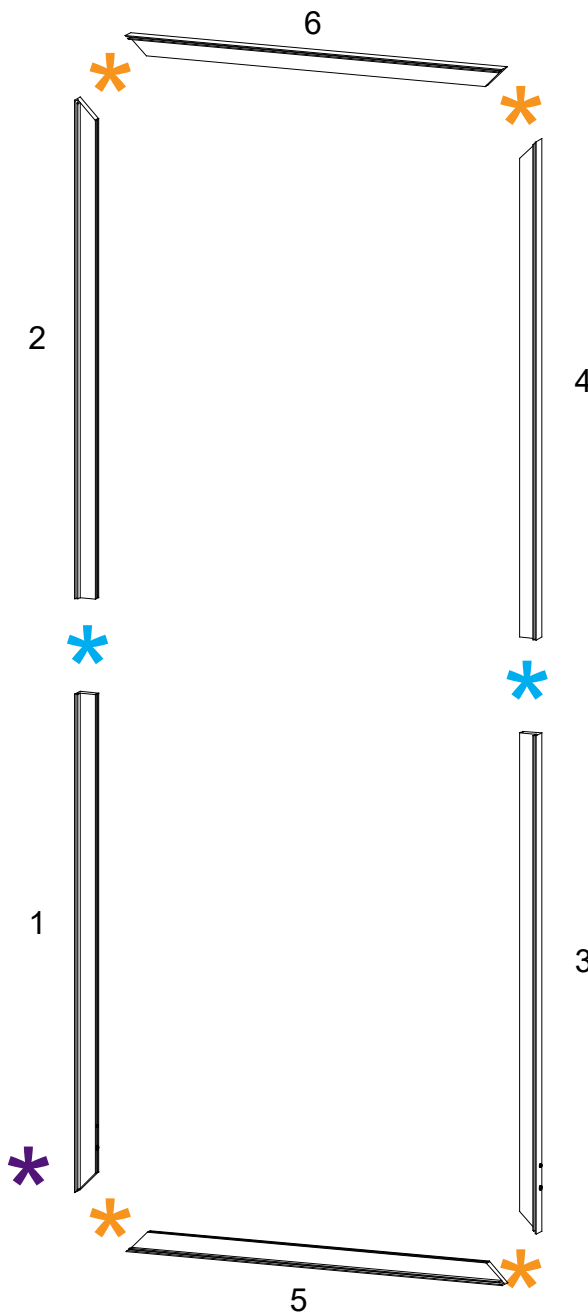

When assembled

Assemble frame flat on ground.

# SETUP INSTRUCTIONS

## General Setup Instructions

- Read entire setup instruction manual prior to unpacking parts and pieces.
- The setup instructions are created specifically for this configuration.
- Setup instructions are laid out sequentially in steps, including exploded views with detailed explanation for assembly.

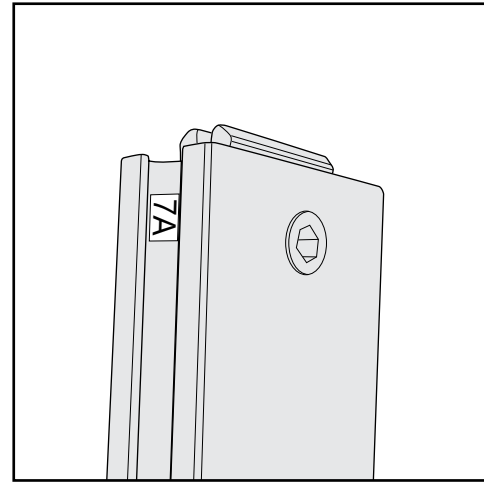

Part Identification - Numbering

## Cleaning & Packing

- For Cleaning Metal, Plex, & Laminate Parts: Use a **MILD NON-ABRASIVE** cleanser and soft cloth/paper towel to clean all surfaces.
- Keep exhibit components away from heat and prolonged sun exposure.  
**Heat and UV exposure will warp and fade components.**
- Retain all provided Packing Materials. All provided packing materials are for ease of repacking & component protection.

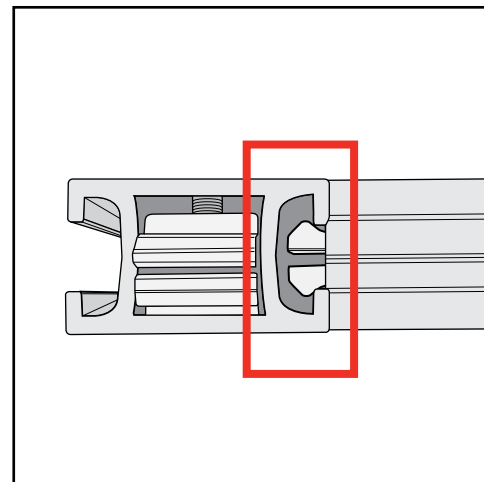

Engaged Lock



# WARNING



DO NOT USE POWER TOOLS



ALL CONNECTIONS MUST  
BE TIGHTLY SECURED

## Disassembly

- For loss prevention, keep all knobs & connectors attached to extrusions during disassembly.

# Top View of Each Level

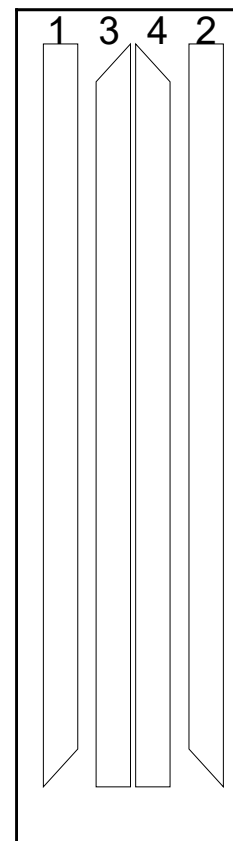

Level 1  
*(Bottom level)*

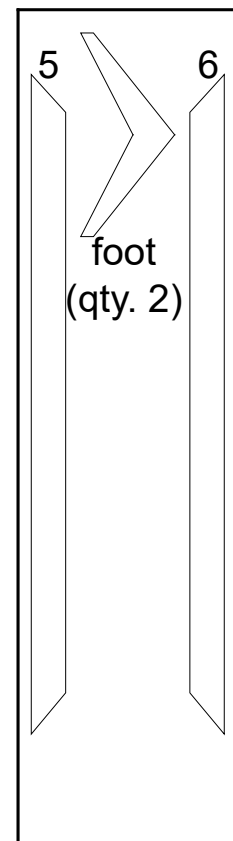

Level 2

